



Catálogo Gama Doméstica

CAINOX®

Especialistas en Sistemas de drenaje
en acero inoxidable

Canal ducha sifónica CLASIC en acero inoxidable

La canal de ducha sifónica más **PLANA**



Ref.	Descripción	Medidas cm
397.068.060	Canal Clasic para ducha	60x6,8x1,1
397.068.070	Canal Clasic para ducha	70x6,8x1,8
397.068.080	Canal Clasic para ducha	80x6,8x1,8

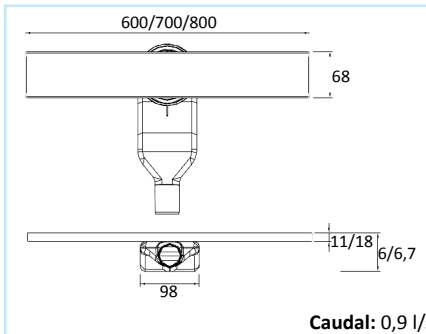

Tela no incluida  Canal apta para la impermeabilización (ver TELA SKY en la página 11)

Canal ducha sifónica ELITE en acero inoxidable



Ref.	Descripción	Medidas cm
399.070.060	Canal Elite para ducha con tela de 1,5x2 m	60x7x1,8
399.070.070	Canal Elite para ducha con tela de 1,5x2 m	70x7x1,8
399.070.080	Canal Elite para ducha con tela de 1,5x2 m	80x7x1,8

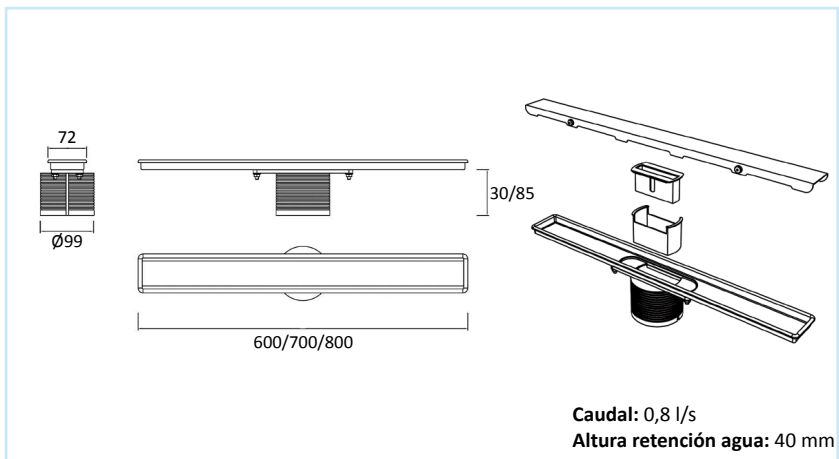

Caudal: 0,8 l/s
Altura retención agua: 40 mm

KIT ECONOMIC para plato de ducha de obra con reja en acero inoxidable



Ref.	Descripción	Medidas cm
800.100 H	Kit ECONOMIC para plato de ducha de obra Salida HORIZONTAL Ø50 mm + tela 1,5x2 m	10x10
800.100 V	Kit ECONOMIC para plato de ducha de obra Salida VERTICAL Ø50 mm + tela 1,5x2 m	10x10
800.150 H	Kit ECONOMIC para plato de ducha de obra Salida HORIZONTAL Ø50 mm + tela 1,5x2 m	15x15
800.150 V	Kit ECONOMIC para plato de ducha de obra Salida VERTICAL Ø50 mm + tela 1,5x2 m	15x15

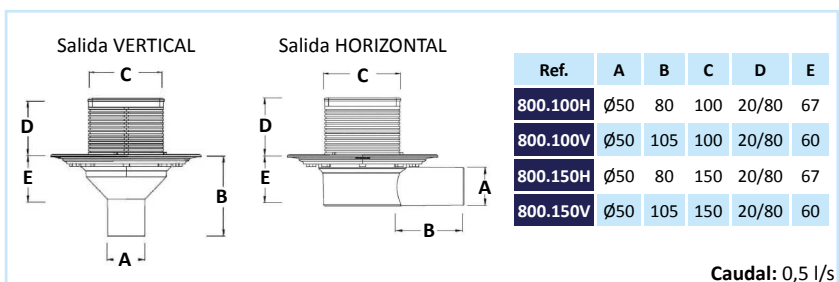

Caudal: 0,5 l/s

Ref.	Descripción	Medidas cm	uds caja
SB-20-1	Sumidero con parte superior en inox. Salida HORIZONTAL/ VERTICAL Ø40/50 mm	11,5x11,5	12

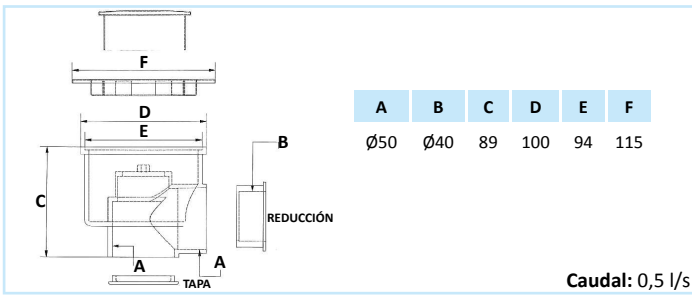

Ref. SB-20-1

Ref.	Descripción	Medidas cm	uds caja
TB-10-1	Sumidero con marco y reja inox. parte inferior polipropileno salida VERTICAL Ø50 mm	10x10	12
TB-10-2	Sumidero con marco y reja inox. parte inferior polipropileno salida HORIZONTAL Ø50 mm	10x10	12
TB-15-1	Sumidero con marco y reja inox. parte inferior polipropileno salida VERTICAL Ø50 mm	15x15	12
TB-15-2	Sumidero con marco y reja inox. parte inferior polipropileno salida HORIZONTAL Ø50 mm	15x15	12

Ref. TB-10-1

Caudal: 0,5 l/s

Ref. TB-10-2

Caudal: 0,5 l/s

Ref. TB-15-1

Caudal: 0,5 l/s

Ref. TB-15-2

Caudal: 0,5 l/s

Incorporan válvula antirretorno extraíble
 Incluyen manguito de unión



Ref.	Descripción	Medidas cm
CD-20A	Sumidero cuadrado con reja inox. lisa + tela 1,5x2 m	20x20
CLL-15	Sumidero cuadrado con reja inox. rellenable + tela 1,5x2 m	15x15
CLL-20	Sumidero cuadrado con reja inox. rellenable + tela 1,5x2 m	20x20

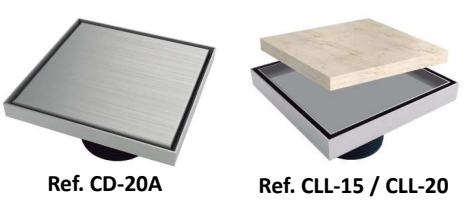

Ref. CD-20A

Caudal: 0,8 l/s

Ref. CLL-15/CLL-20

Caudal: 0,8 l/s

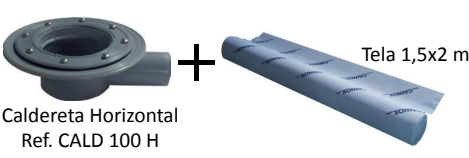

Incorpora válvula antirretorno extraíble
 Incluye manguito de unión

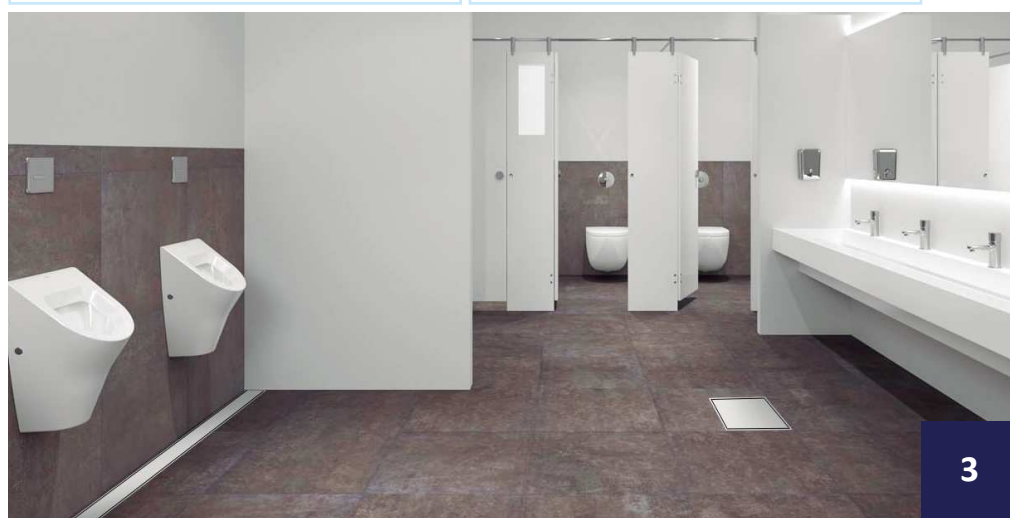

Sumideros sifónicos DISEÑO ECONOMIC pulido espejo en acero inoxidable



Ref. 510.100



Ref. 510.101



Ref. 510.150



Ref. 510.151



Ref. 510.200



Ref. 510.201



Ref. 510.300



Ref. 510.301

Ref.	Descripción	Medidas cm
510.100	Sumidero inox. salida VERTICAL Ø50 mm sifónico	10x10
510.101	Sumidero inox. salida HORIZONTAL Ø50 mm sifónico	10x10

Incluyen manguito de unión

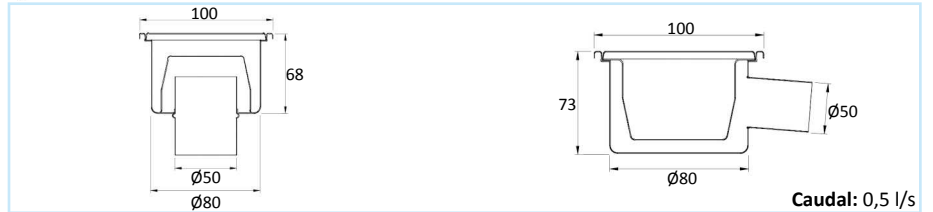

Ref.	Descripción	Medidas cm
510.150	Sumidero inox. salida VERTICAL Ø50 mm sifónico	15x15
510.151	Sumidero inox. salida HORIZONTAL Ø50 mm sifónico	15x15

Incluyen manguito de unión

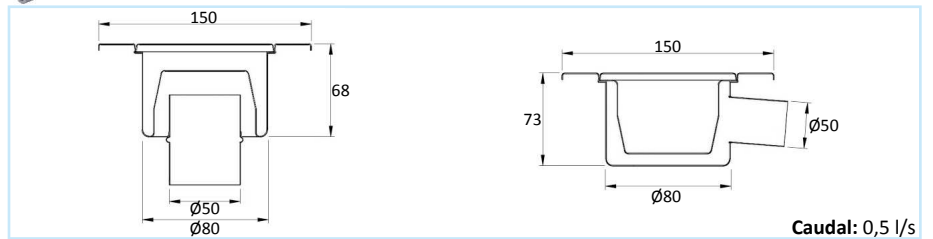

Ref.	Descripción	Medidas cm
510.200	Sumidero inox. salida VERTICAL Ø75 mm sifónico	20x20
510.201	Sumidero inox. salida HORIZONTAL Ø75 mm sifónico	20x20

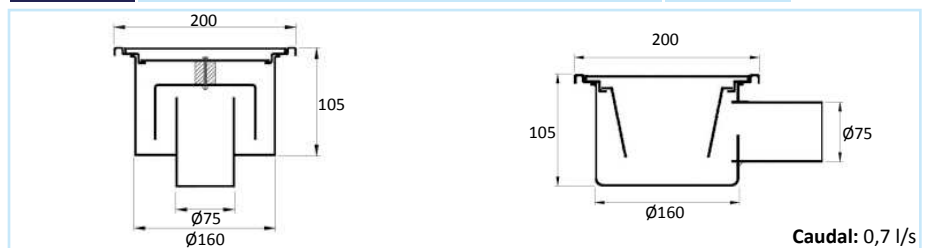

Ref.	Descripción	Medidas cm
510.300	Sumidero inox. salida VERTICAL Ø110 mm sifónico con filtro extraíble	30x30
510.301	Sumidero inox. salida HORIZONTAL Ø75 mm sifónico con filtro extraíble	30x30

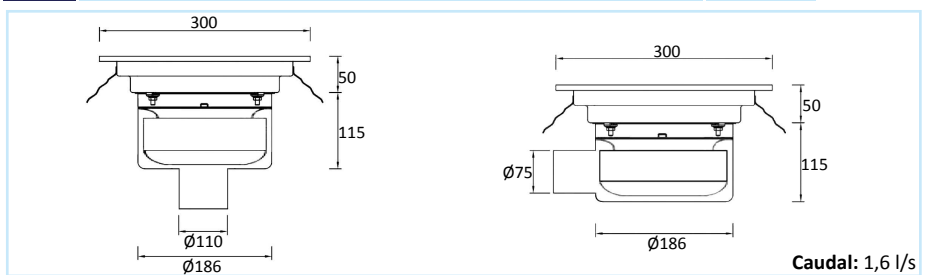

Canal ELEGANCE en acero inoxidable

Canal oculta con embellecedor de pared
Sifón extraplano y fácil limpieza

Ref. ELG-60



Ref.	Descripción	Medidas cm
ELG-60	Canal Elegance para ducha embellecedor SATINADO	8,5x68

Sifón apto para impermeabilización con tela o pintura / Otras medidas bajo petición

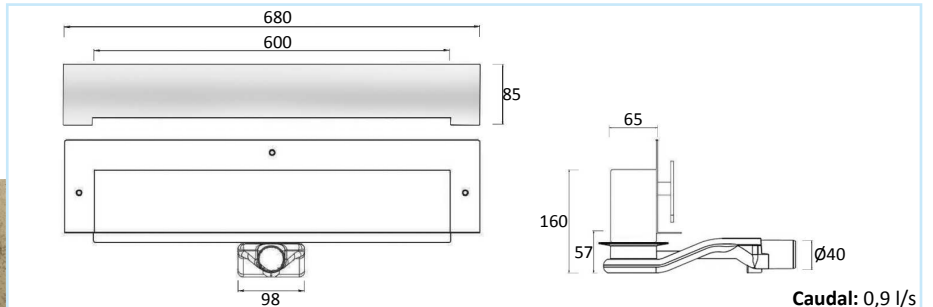

Sumideros no sifónicos DISEÑO ECONOMIC

Acabado cristal

Ref.	Descripción	Medidas cm
500.001	Sumidero con marco y reja inox. blanco salida VERT-HORIZ. Ø50 mm	11x11
500.002	Sumidero con marco y reja inox. gris salida VERT-HORIZ. Ø50 mm	11x11

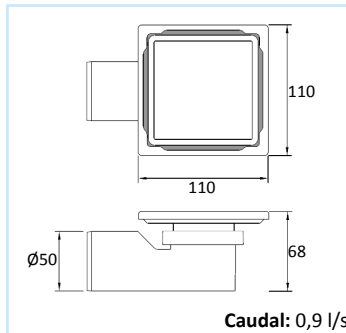

Caudal: 0,9 l/s



Ref. 500.001



Ref. 500.002



Con filtro
y
válvula antirretorno extraíbles

Sumideros sifónicos DISEÑO ECONOMIC

Acabado cristal

Ref.	Descripción	Medidas cm
500.001sif	Sumidero sifónico con marco y reja inox. blanco S/H Ø40 mm	11x11
500.002sif	Sumidero sifónico con marco y reja inox. gris S/H Ø40 mm	11x11

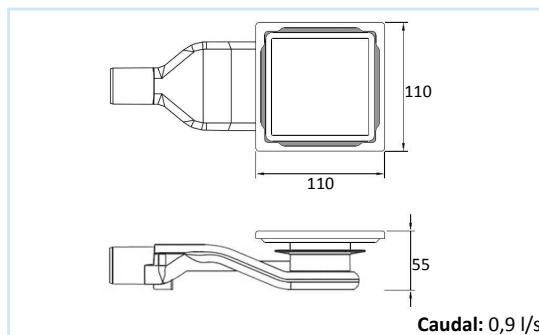

Caudal: 0,9 l/s



Ref. 500.001sif

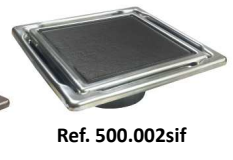

Ref. 500.002sif



NUEVO sifón con
tela termosoldada



Incorpora filtro y
válvula antirretorno
extraíbles

Sumideros aptos para la impermeabilización
(ver TELA SKY en la página 11)

Sumidero sifónico triangular DISEÑO ECONOMIC en acero inoxidable

Ref.	Descripción	Medidas cm
TR-22A	Sumidero triangular reja inox. + tela 1,5x2 m	21,5x 21,5x30,4

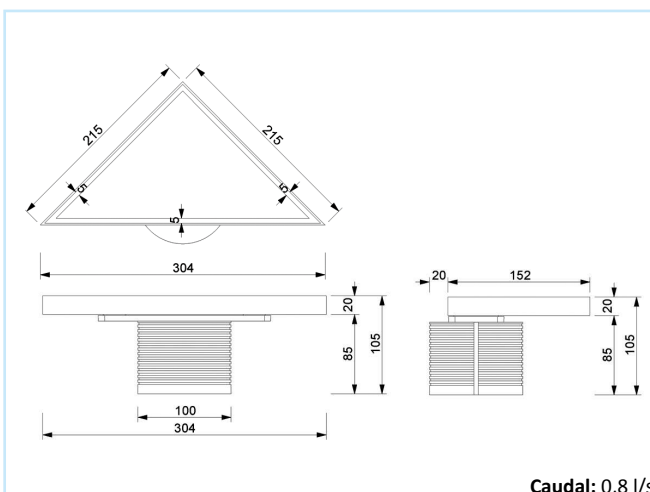

Caudal: 0,8 l/s



Ref. TR-22A



Caldereta Horizontal
Ref. CALD 100 H

Tela 1,5x2 m



Incorpora válvula antirretorno extraíble
Incluye manguito de unión

Otra opción: cambio de accesorio SIN coste adicional



Caldereta Vertical
Ref. CALD 101 V

Canal ducha sifónica PREMIUM en acero inoxidable

LONGITUDES ESPECIALES
FABRICACIÓN A MEDIDA



Ref. 699.100

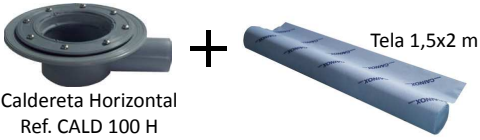

Caldereta Horizontal
Ref. CALD 100 H

Incluye manguito de unión

Otra opción: cambio de accesorio SIN coste adicional



Caldereta Vertical
Ref. CALD 101 V

Ref.	Descripción	Medidas cm
699.100.060	Canal Premium para ducha + tela 1,5x2 m	60x13x2,5
699.100.070	Canal Premium para ducha + tela 1,5x2 m	70x13x2,5
699.100.080	Canal Premium para ducha + tela 1,5x2 m	80x13x2,5
699.100.090	Canal Premium para ducha + tela 1,5x2 m	90x13x2,5
699.100.100	Canal Premium para ducha + tela 1,5x2 m	100x13x2,5

Canales de longitudes especiales y rejas personalizadas bajo petición

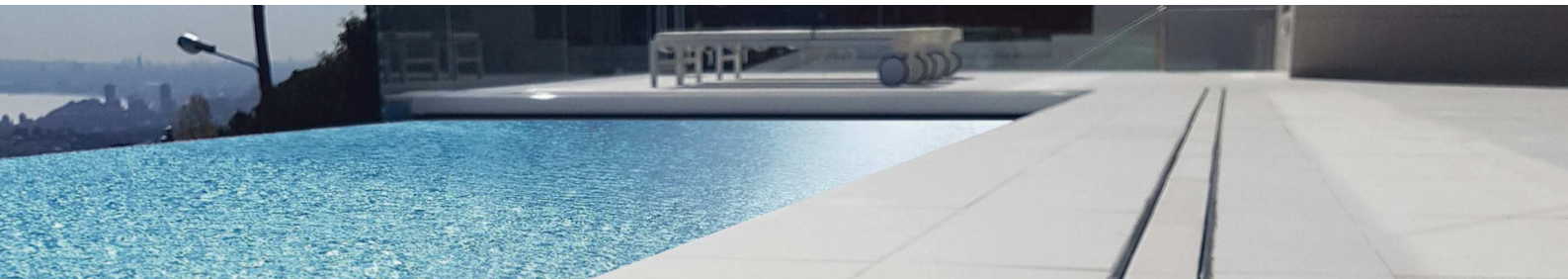
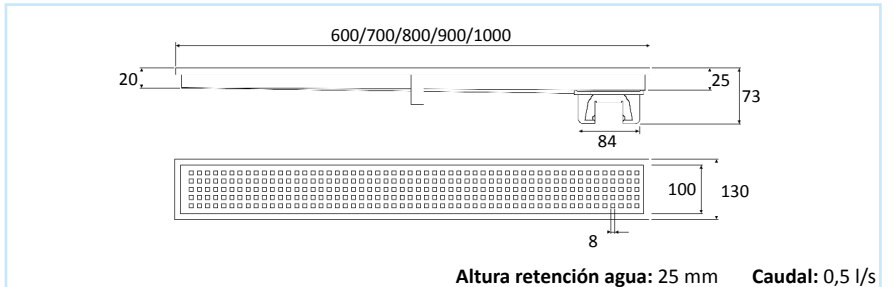
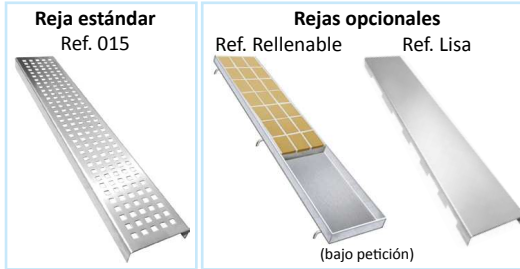

Sumideros sifónicos PREMIUM en acero inoxidable

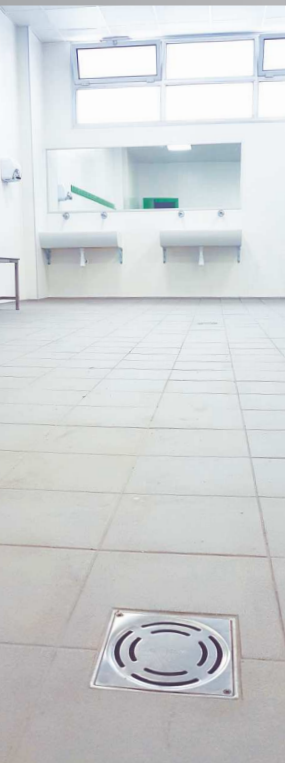

Ref. 084.100



Ref. 084.150



Ref. 084.200

Ref.	Descripción	Medidas cm	uds caja
084.100.040	Sumidero salida VERT- HORIZ. Ø40/50 mm	10x10	12
084.100.040T	Idem (con tornillo)	10x10	12
084.150.050	Sumidero salida VERT- HORIZ. Ø50 mm	15x15	8
084.150.050T	Idem (con tornillo)	15x15	8
084.200.050T	Sum. salida VERT- HORIZ. Ø50 mm (con tornillos)	20x20	8

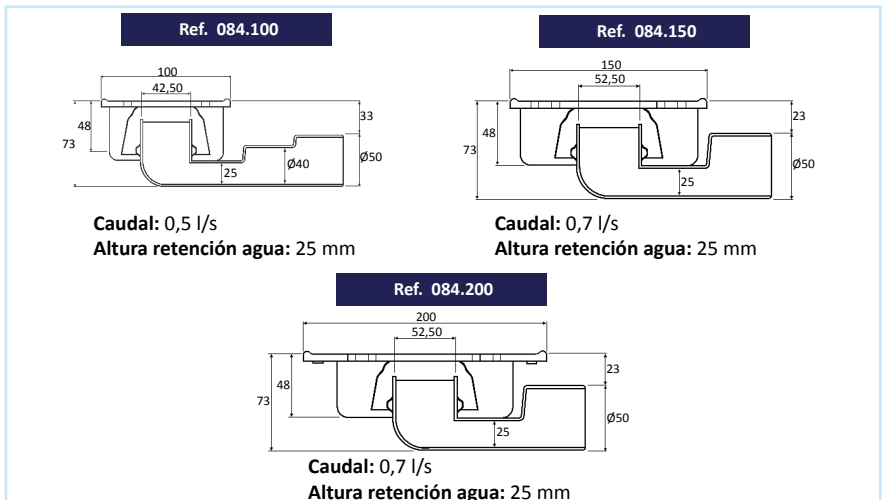

Sumideros sifónicos PREMIUM en acero inoxidable (sifón extraíble)

Ref.	Descripción	Medidas cm
086.100.075WT	Sumidero con sifón extraíble salida VERTICAL Ø75 mm	10x10
086.150.075WT	Sumidero con sifón extraíble salida VERTICAL Ø75 mm	15x15
086.150.110WT	Sumidero con sifón extraíble salida VERTICAL Ø110 mm	15x15
086.200.110WT	Sumidero con sifón extraíble salida VERTICAL Ø110 mm	20x20

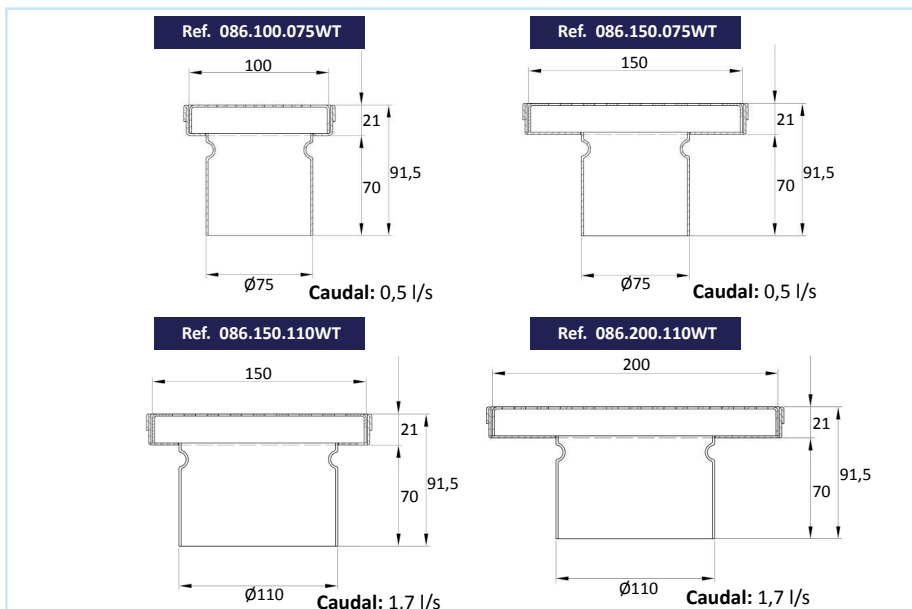

Sumideros no sifónicos PREMIUM en acero inoxidable

Ref.	Descripción	Medidas cm
086.100.075	Sumidero no sifónico salida VERTICAL Ø75 mm	10x10
086.150.075	Sumidero no sifónico salida VERTICAL Ø75 mm	15x15
086.150.110	Sumidero no sifónico salida VERTICAL Ø110 mm	15x15
086.200.110	Sumidero no sifónico salida VERTICAL Ø110 mm	20x20

Marcos y Rejas en acero inoxidable

Ref.	Descripción	Medidas cm	uds caja
695.100	Marco y reja atornillada con dos escuadras de fijación	10x10	10
695.150	Marco y reja atornillada con dos escuadras de fijación	15x15	10

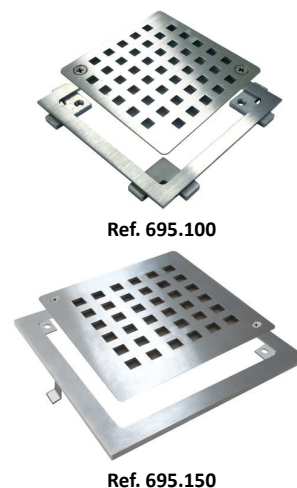
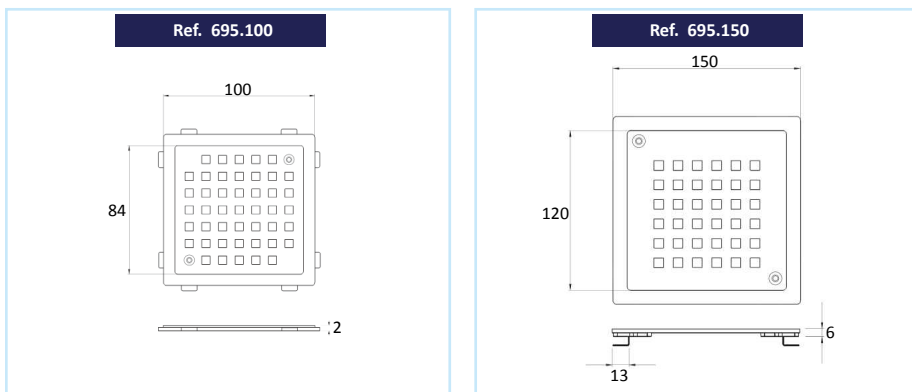

Canal sifónica para duchas **DISEÑO** en acero inoxidable

LONGITUDES ESPECIALES
FABRICACIÓN A MEDIDA



Ref.	Descripción	Medidas cm
590.080.060	Canal Diseño para ducha + tela 1,5x2 m	60x8x2,5
590.080.070	Canal Diseño para ducha + tela 1,5x2 m	70x8x2,5
590.080.080	Canal Diseño para ducha + tela 1,5x2 m	80x8x2,5
590.080.090	Canal Diseño para ducha + tela 1,5x2 m	90x8x2,5
590.080.100	Canal Diseño para ducha + tela 1,5x2 m	100x8x2,5

Canales de longitudes especiales y rejillas personalizadas bajo petición

Reja estándar Ref. Lisa	Reja opcional Ref. Rellenable (bajo petición)	Medidas cm
		600/700/800/900/1000 20 25 78,40 805041

Caudal: 0,9 l/s

Sumideros sifónicos **DISEÑO ESTANCOS** en acero inoxidable (con sifón extraíble)



NOVEDAD

Ref.	Descripción	Medidas cm
CAI 150 E VA 110	Sumidero estanco salida VERTICAL Ø110 mm con tirador	15x15
CAI 160 RE MC VA 110	Sumidero estanco con salida VERTICAL Ø110 mm (incluye ventosa)	Ø16
CAI 160 RE VA 110 VIN	Sumidero estanco para suelo vinílico salida VERTICAL Ø110 mm con tirador	Ø16



Ref. CAI 150 E VA 110



Ref. CAI 160 RE MC VA 110
Ventosa incluida



Ref. CAI 160 RE VA 110 VIN

DN	Ø110
H	120
W	150
hr	10

Caudal: 1,7 l/s

DN	Ø110
H	143
Ø	160
hr	27

Caudal: 1,7 l/s

D	Ø110
H	165
Ø	220
Ø1	164

Caudal: 1,7 l/s

Sumidero sifónico redondo **DISEÑO** en acero inoxidable (con sifón extraíble)



Ref. CAI 160R MC VA 110 K3

Ref.	Descripción	Medidas cm
CAI 160R MC VA 110 K3	Sumidero redondo salida VERTICAL Ø110 mm	Ø16

DN	Ø110
H	145
Ø	160
hr	5

Caudal: 1,7 l/s



Sumideros sifónicos **DISEÑO** en acero inoxidable (con sifón extraíble)

Ref.	Descripción	Medidas cm
CAI 150 MC VA 050 K3	Sumidero salida VERTICAL Ø50 mm	15x15
CAI 150 MC VA 075 K3	Sumidero salida VERTICAL Ø75 mm	15x15
CAI 150 MC VA 110 K3	Sumidero salida VERTICAL Ø110 mm	15x15

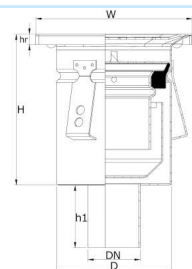
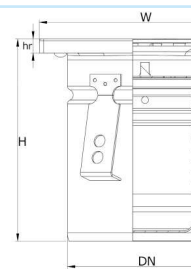
	DN Ø50/Ø75 H 132,5 h1 60 D Ø110 W 150 hr 10		DN Ø110 H 120 W 150 hr 10
Caudal: 1,7 l/s		Caudal: 1,7 l/s	

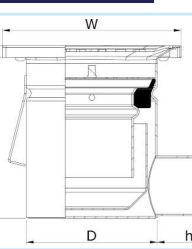
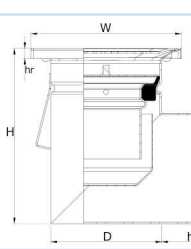

Ref.	Descripción	Medidas cm
CAI 150 MC HA 050 K3	Sumidero salida HORIZONTAL Ø50 mm	15x15
CAI 150 MC HA 075 K3	Sumidero salida HORIZONTAL Ø75 mm	15x15
CAI 150 MC HA 110 K3	Sumidero salida HORIZONTAL Ø110 mm	15x15

	DN Ø50/Ø75 H 132,5 h1 60 D Ø110 W 150 hr 10		DN Ø110 H 165 h1 60 D Ø110 W 150 hr 10
Caudal: 1,7 l/s		Caudal: 1,7 l/s	

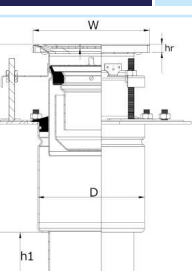
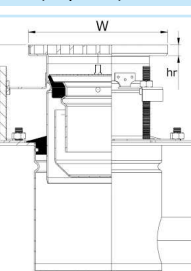

Ref.	Descripción	Medidas cm
CAI 150 MC VA2 050 K3	Sumidero salida VERTICAL Ø50 mm (Imp.Tela)	15x15
CAI 150 MC VA2 075 K3	Sumidero salida VERTICAL Ø75 mm (Imp.Tela)	15x15
CAI 150 MC VA2 110 K3	Sumidero salida VERTICAL Ø110 mm (Imp.Tela)	15x15
CAI 150 MC HA2 050 K3	Sumidero salida HORIZONTAL Ø50 mm (Imp.Tela)	15x15
CAI 150 MC HA2 075 K3	Sumidero salida HORIZONTAL Ø75 mm (Imp.Tela)	15x15
CAI 150 MC HA2 110 K3	Sumidero salida HORIZONTAL Ø110 mm (Imp.Tela)	15x15

	DN Ø50/Ø75/Ø110 H 130 h1 60 h2 65-105 D Ø137 W 150 hr 10		DN Ø50/Ø75/Ø110 H 135 h1 60 h2 65-105 D Ø137 W 150 hr 10
Caudal: 1,7 l/s		Caudal: 1,7 l/s	

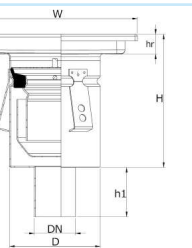
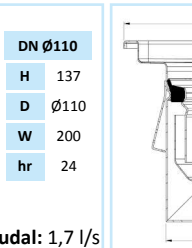
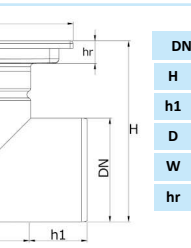
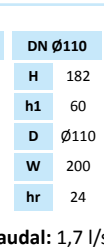

Ref.	Descripción	Medidas cm
CAI 200 MC VA 075	Sumidero salida VERTICAL Ø75 mm	20x20
CAI 200 MC VA 110	Sumidero salida VERTICAL Ø110 mm	20x20
CAI 200 MC HA 075	Sumidero salida HORIZONTAL Ø75 mm	20x20
CAI 200 MC HA 110	Sumidero salida HORIZONTAL Ø110 mm	20x20

	DN Ø75 H 149,5 h1 60 D Ø110 W 200 hr 24		DN Ø110 H 137 D Ø110 W 200 hr 24		DN Ø75 H 149,5 h1 60 D Ø110 W 200 hr 24		DN Ø110 H 182 h1 60 D Ø110 W 200 hr 24
Caudal: 1,7 l/s				Caudal: 1,7 l/s			



Reja estándar CAI 200		Rejas opcionales bajo petición para CAI 200					
Ref. RA11 Perforada antideslizante Clase L		Ref. RA13 Entramada Clase L		Ref. RA14 Ranurada Clase M		Ref. RA15 De pletinas Clase M	

Canal ducha sifónica BASIC en acero inoxidable

LONGITUDES ESPECIALES
FABRICACIÓN A MEDIDA

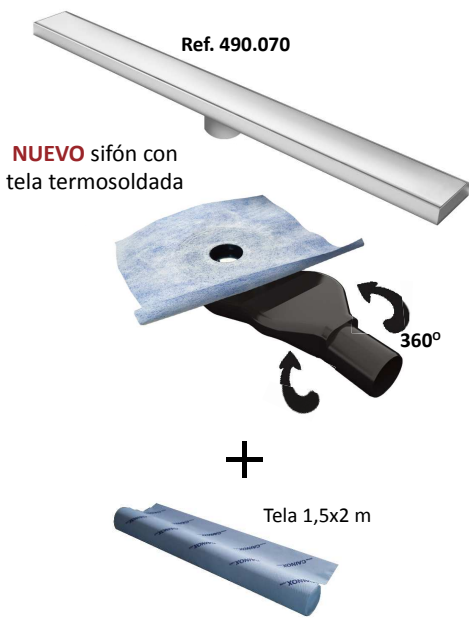

Ref.	Descripción	Medidas cm
490.070.060	Canal Basic para ducha + tela 1,5x2 m	60x7x2,5
490.070.070	Canal Basic para ducha + tela 1,5x2 m	70x7x2,5
490.070.080	Canal Basic para ducha + tela 1,5x2 m	80x7x2,5
490.070.090	Canal Basic para ducha + tela 1,5x2 m	90x7x2,5
490.070.100	Canal Basic para ducha + tela 1,5x2 m	100x7x2,5

Canales de longitudes especiales y rejillas personalizadas bajo petición

Reja estándar
Lisa y rellenable

Dos acabados en una misma reja reversible

Reja opcional
Ref. 015

Opción sin coste adicional

Caudal: 0,9 l/s



Sumideros sifónicos BASIC en acero inoxidable



Ref. 082.1

Ref.	Descripción	Medidas cm	uds caja
082.100.040	Sumidero salida VERTICAL Ø40 mm	10x10	20
082.150.040	Sumidero salida VERTICAL Ø40 mm	15x15	10

Ref.	A	B	C	D	E	F
082.100.040	100	90	86	50	28	Ø40
082.150.040	150	127	120	70	35	Ø40

Caudal: 0,4 - 0,5 l/s



Ref. 082.2

Ref.	Descripción	Medidas cm
082.150.050	Sumidero salida VERTICAL Ø50 mm	15x15
082.150.050C	Sumidero salida VERTICAL Ø50 mm (con cesta filtro)	15x15
082.200.063	Sumidero salida VERTICAL Ø63 mm	20x20
082.200.063T	Sumidero salida VERTICAL Ø63 mm (con tornillo)	20x20
082.200.063C	Sumidero salida VERTICAL Ø63 mm (con cesta filtro)	20x20
082.250.080C	Sumidero salida VERTICAL Ø80 mm (con cesta filtro)	25x25
082.300.110C	Sumidero salida VERTICAL Ø110 mm (con cesta filtro)	30x30

Ref.	A	B	C	D	E	Caudal l/s
082.150.050	150	80	110	Ø50	35	0,94
082.200.063	200	85	150	Ø63	60	1,24
082.250.080	250	115	195	Ø80	60	1,85
082.300.110	300	126	220	Ø110	60	2,34



Ref. 083

Ref.	Descripción	Medidas cm
083.100.040	Sumidero redondo sifónico	Ø10

A	B	C	D	E
Ø100	56	85	Ø40	33

Caudal: 0,34 l/s

TELA IMPERMEABILIZANTE Y VÁLVULAS ANTIRRETORNO

TELA Impermeabilizante SKY de tres capas

Tela SKY
también de 1 metro de anchura

Ref.	Descripción 1,5 m de ancho	Medidas m	m ²
TELA	Tela impermeabilizante SKY de 1,5 m de ancho	2x1,5	3
BOBINA 5	Tela impermeabilizante SKY de 1,5 m de ancho	5x1,5	7,5
BOBINA 10	Tela impermeabilizante SKY de 1,5 m de ancho	10x1,5	15
BOBINA 20	Tela impermeabilizante SKY de 1,5 m de ancho	20x1,5	30

Ref.	Descripción 1 m de ancho	Medidas m	m ²
PIEZA	Tela impermeabilizante SKY de 1 m de ancho	2x1	2
ROLLO 5	Tela impermeabilizante SKY de 1 m de ancho	5x1	5
ROLLO 10	Tela impermeabilizante SKY de 1 m de ancho	10x1	10
ROLLO 20	Tela impermeabilizante SKY de 1 m de ancho	20x1	20

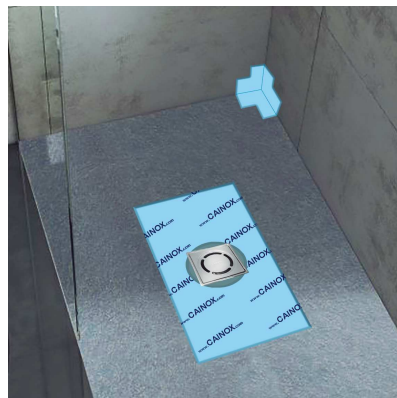

Ref.	Descripción
INTERIOR 115	Esquina Interior tela de tres capas
EXTERIOR 120	Esquina Exterior tela de tres capas

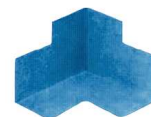

Ref. INTERIOR 115

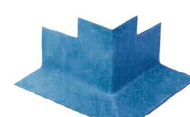

Ref. EXTERIOR 120

Válvulas Antirretorno

Ref.	Descripción	Medidas cm
CV - 75	Válvula antirretorno con llave de bloqueo	Ø75
CV - 110	Válvula antirretorno con llave de bloqueo	Ø110
CV - 125	Válvula antirretorno con llave de bloqueo	Ø125
CV - 160	Válvula antirretorno con llave de bloqueo	Ø160
CV - 200	Válvula antirretorno con llave de bloqueo	Ø200
CV - 250	Válvula antirretorno con llave de bloqueo	Ø250
CV - 315	Válvula antirretorno con llave de bloqueo	Ø315

Ref. CV

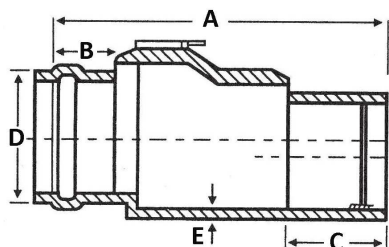

Ref.	A	B	C	D	E
CV - 75	231	40	57	Ø75	2
CV - 110	318	65	64	Ø110	3,5
CV - 125	318	70	71	Ø125	4,1
CV - 160	350	70	70	Ø160	4,1
CV - 200	450	110	89	Ø200	4,1
CV - 250	566	144	104	Ø250	6,2
CV - 315	728	183	144	Ø315	7,7



PEATONAL Tapas de registro estancas

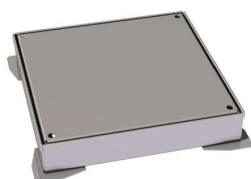

Ref. TR01.MAP



Ref. TR01.ANP



Ref. TR05.P

* medidas 80, 90 y 100 bajo petición

Ref.	Descripción	Medidas cm
TR01.300.300MAP	Tapa registro mate Peatonal	30x30x7
TR01.400.400MAP	Tapa registro mate Peatonal	40x40x7
TR01.500.500MAP	Tapa registro mate Peatonal	50x50x7
TR01.600.600MAP	Tapa registro mate Peatonal	60x60x7
TR01.700.700MAP	Tapa registro mate Peatonal	70x70x7
* TR01.800.800MAP	Tapa registro mate Peatonal	80x80x7
* TR01.900.900MAP	Tapa registro mate Peatonal	90x90x7
* TR01.1000.1000MAP	Tapa registro mate Peatonal	100x100x7
TR01.300.300ANP	Tapa registro antideslizante Peatonal	30x30x7
TR01.400.400ANP	Tapa registro antideslizante Peatonal	40x40x7
TR01.500.500ANP	Tapa registro antideslizante Peatonal	50x50x7
TR01.600.600ANP	Tapa registro antideslizante Peatonal	60x60x7
TR01.700.700ANP	Tapa registro antideslizante Peatonal	70x70x7
* TR01.800.800ANP	Tapa registro antideslizante Peatonal	80x80x7
* TR01.900.900ANP	Tapa registro antideslizante Peatonal	90x90x7
* TR01.1000.1000ANP	Tapa registro antideslizante Peatonal	100x100x7
TR05.300.300P	Tapa registro rellenable Peatonal	30x30x7
TR05.400.400P	Tapa registro rellenable Peatonal	40x40x7
TR05.500.500P	Tapa registro rellenable Peatonal	50x50x7
TR05.600.600P	Tapa registro rellenable Peatonal	60x60x7
TR05.700.700P	Tapa registro rellenable Peatonal	70x70x7
* TR05.800.800P	Tapa registro rellenable Peatonal	80x80x7
* TR05.900.900P	Tapa registro rellenable Peatonal	90x90x7
* TR05.1000.1000P	Tapa registro rellenable Peatonal	100x100x7

TRAFICO MEDIO/PESADO Tapas de registro estancas

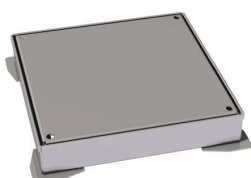

Ref. TR01.MAT



Ref. TR01.ANT



Ref. TR05

* medidas 80, 90 y 100 bajo petición

Ref.	Descripción	Medidas cm
TR01.300.300MAT	Tapa registro mate Reforzada	30x30x7
TR01.400.400MAT	Tapa registro mate Reforzada	40x40x7
TR01.500.500MAT	Tapa registro mate Reforzada	50x50x7
TR01.600.600MAT	Tapa registro mate Reforzada	60x60x7
TR01.700.700MAT	Tapa registro mate Reforzada	70x70x7
* TR01.800.800MAT	Tapa registro mate Reforzada	80x80x7
* TR01.900.900MAT	Tapa registro mate Reforzada	90x90x7
* TR01.1000.1000MAT	Tapa registro mate Reforzada	100x100x7
TR01.300.300ANT	Tapa registro antideslizante Reforzada	30x30x7
TR01.400.400ANT	Tapa registro antideslizante Reforzada	40x40x7
TR01.500.500ANT	Tapa registro antideslizante Reforzada	50x50x7
TR01.600.600ANT	Tapa registro antideslizante Reforzada	60x60x7
TR01.700.700ANT	Tapa registro antideslizante Reforzada	70x70x7
* TR01.800.800ANT	Tapa registro antideslizante Reforzada	80x80x7
* TR01.900.900ANT	Tapa registro antideslizante Reforzada	90x90x7
* TR01.1000.1000ANT	Tapa registro antideslizante Reforzada	100x100x7
TR05.300.300	Tapa registro rellenable Reforzada	30x30x8
TR05.400.400	Tapa registro rellenable Reforzada	40x40x8
TR05.500.500	Tapa registro rellenable Reforzada	50x50x8
TR05.600.600	Tapa registro rellenable Reforzada	60x60x8
TR05.700.700	Tapa registro rellenable Reforzada	70x70x8
* TR05.800.800	Tapa registro rellenable Reforzada	80x80x8
* TR05.900.900	Tapa registro rellenable Reforzada	90x90x8
* TR05.1000.1000	Tapa registro rellenable Reforzada	100x100x8



Todas las rejillas de ventilación incorporan malla anti-mosquitos



Ref. GINT



Ref. GIN 10 R



Ref. GIN 14 R



Ref. GIN 106 R

Ref.	Descripción	Medidas cm	uds caja
GINT 125 R	Rejilla ventilación redonda	Ø12,5	1
GINT 160 R	Rejilla ventilación redonda	Ø16	1
GINT 200 R	Rejilla ventilación redonda	Ø20	1

Ref.	Descripción	Medidas cm	uds caja
GIN 10 R	Rejilla ventilación - 1 Módulo	14x14x0,5	10
GIN 20 R	Rejilla ventilación - 2 Módulos	24x14x0,5	10
GIN 30 R	Rejilla ventilación - 3 Módulos	34x14x0,5	10
GIN 40 R	Rejilla ventilación - 4 Módulos	44x14x0,5	5
GIN 50 R	Rejilla ventilación - 5 Módulos	54x14x0,5	5
GIN 60 R	Rejilla ventilación - 6 Módulos	64x14x0,5	5

GIN 14 R	Rejilla ventilación - 1 Módulo	14x24x0,5	10
GIN 24 R	Rejilla ventilación - 2 Módulos	24x24x0,5	10
GIN 34 R	Rejilla ventilación - 3 Módulos	34x24x0,5	10
GIN 44 R	Rejilla ventilación - 4 Módulos	44x24x0,5	5
GIN 54 R	Rejilla ventilación - 5 Módulos	54x24x0,5	5
GIN 64 R	Rejilla ventilación - 6 Módulos	64x24x0,5	5

GIN 106 R	Rejilla ventilación - 1 Módulo	10x6x0,5	10
GIN 206 R	Rejilla ventilación - 2 Módulos	20x6x0,5	10
GIN 306 R	Rejilla ventilación - 3 Módulos	30x6x0,5	10
GIN 406 R	Rejilla ventilación - 4 Módulos	40x6x0,5	5
GIN 506 R	Rejilla ventilación - 5 Módulos	50x6x0,5	5
GIN 606 R	Rejilla ventilación - 6 Módulos	60x6x0,5	5

Calderetas



Ref.	Descripción
CALD 100 H	Caldereta polipropileno recogetela salida HORIZONTAL (con BRIDA)
CALD 101 V	Caldereta polipropileno recogetela salida VERTICAL (con BRIDA)
CALD 102 H	Caldereta PVC recogetela salida HORIZONTAL (sin BRIDA)
CALD 103 V	Caldereta PVC recogetela salida VERTICAL (sin BRIDA)
CALD MIXTA 100	Caldereta PVC recogetela salida HORIZONTAL/VERTICAL (sin BRIDA)
CALD MIXTA 150	Caldereta PVC recogetela salida HORIZONTAL/VERTICAL (sin BRIDA)



Ref. CALD 100 H

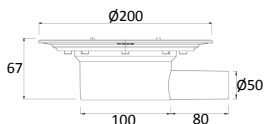

Ref. CALD 101 V

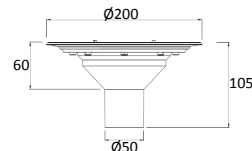

Ref. CALD 102 H

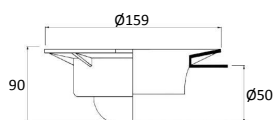

Ref. CALD 103 V

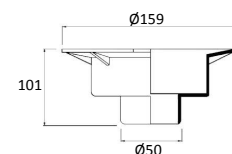

Ref. CALD MIXTA 150

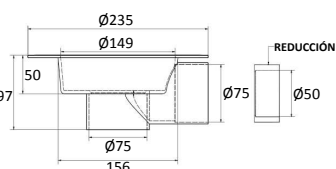

Ref. CALD MIXTA 100

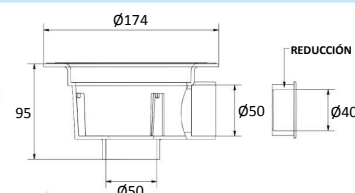

Protección Anti-Aves en acero inoxidable

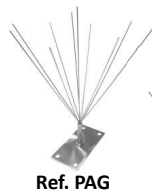

Ref. PAG

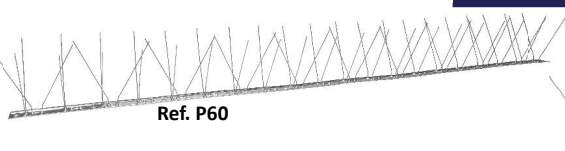

Ref. P60

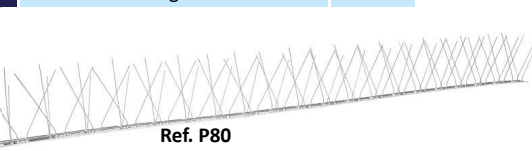

Ref. P80

NOVEDAD

Ref.	Descripción	uds caja
P60	60 púas anti-aves de 100 cm	25
P80	80 púas anti-aves de 100 cm	25
PAG	Protección aves grandes	1



Accesorios



NOVEDAD

Ref.	Descripción	uds caja
360S	Sifón extraplano de plástico ABS apto para impermeabilización con Tela SKY, salida Ø40 mm	1
360ST	Sifón extraplano de plástico ABS con tela impermeabilizante termosoldada, salida Ø40 mm	1
SCD50	Codo de plástico ABS con junta de estanqueidad salida horizontal Ø50 mm	1
MANGUITO 50	Manguito de unión de PVC con junta H/H para conectar a cualquier tubo de Ø50 mm	12
MORRION	Morrión en acero inoxidable anti-hojas para tubos de Ø60-Ø120	1

Ref.	Descripción	uds caja	
Ref. 360S	Filtro recoge-cabellos		
Ref. 360ST	Pieza superior del sifón con pliegue premarcado para doblar y adaptar a instalaciones junto a la pared		 
Ref. SCD50			 
Ref. MANGUITO 50			 
Ref. MORRION			

Abrazaderas en acero inoxidable (sin fin)



Ref. SBMULTI

Sugerencias de montaje:







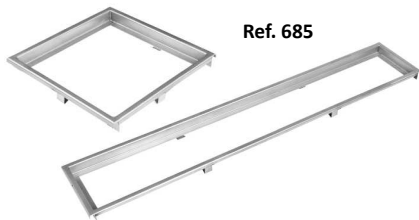

Ref.	Descripción
SBMULTI	Juego completo
CABEZ SBMULTI	Cabezales (25 cabezales)
CINTA SBMULTI	Cinta (8 mm x 5 m)

Marcos en acero inoxidable

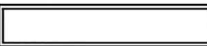
LONGITUDES ESPECIALES
FABRICACIÓN A MEDIDA





Tipo	Ref.	Descripción	Medidas cm
	685.20.20	Marco	20x20x2,5
	685.30.30	Marco	30x30x2,5
Tipo	Ref.	Descripción	Medidas cm
	685.100.100	Marco	10x100x2,5
	685.150.100	Marco	15x100x2,5
	685.100.150	Marco	10x150x2,5
	685.150.150	Marco	15x150x2,5

Rejas en acero inoxidable

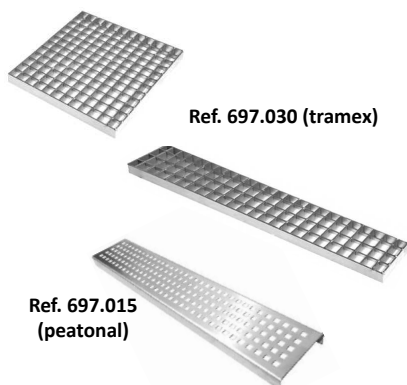
LONGITUDES ESPECIALES
FABRICACIÓN A MEDIDA

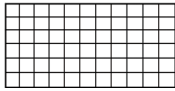
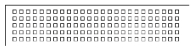

Tipo	Ref.	Descripción	Medidas cm
	697.030.20.20	Reja Tráfico Medio	16,7x16,7x2,5
	697.030.30.30	Reja Tráfico Medio	26,7x26,7x2,5
	697.168.00.02	Reja Peatonal	16,7x16,7x2,5
Tipo	Ref.	Descripción	Medidas cm
	697.030.10.100	Reja Tráfico Medio	10x100x2,5
	697.030.15.100	Reja Tráfico Medio	15x100x2,5
	697.030.10.150	Reja Tráfico Medio	10x150x2,5
	697.030.15.150	Reja Tráfico Medio	15x150x2,5
Tipo	Ref.	Descripción	Medidas cm
	697.015.10.100	Reja Peatonal	10x100x2,5
	697.015.15.100	Reja Peatonal	15x100x2,5
	697.015.10.150	Reja Peatonal	10x150x2,5
	697.015.15.150	Reja Peatonal	15x150x2,5

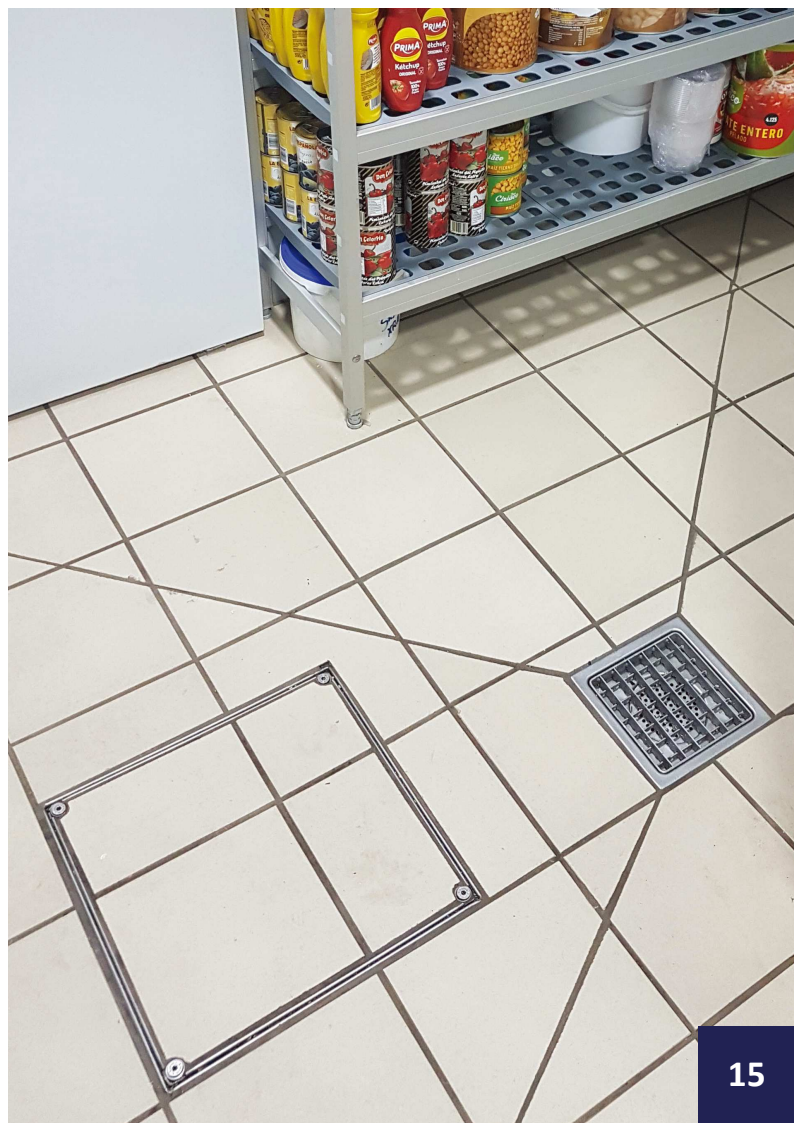

Gama Industrial

Fabricación a medida
Amplia Gama de Productos



www.cainox.com

